



dark & bright star

loomma



inspiration



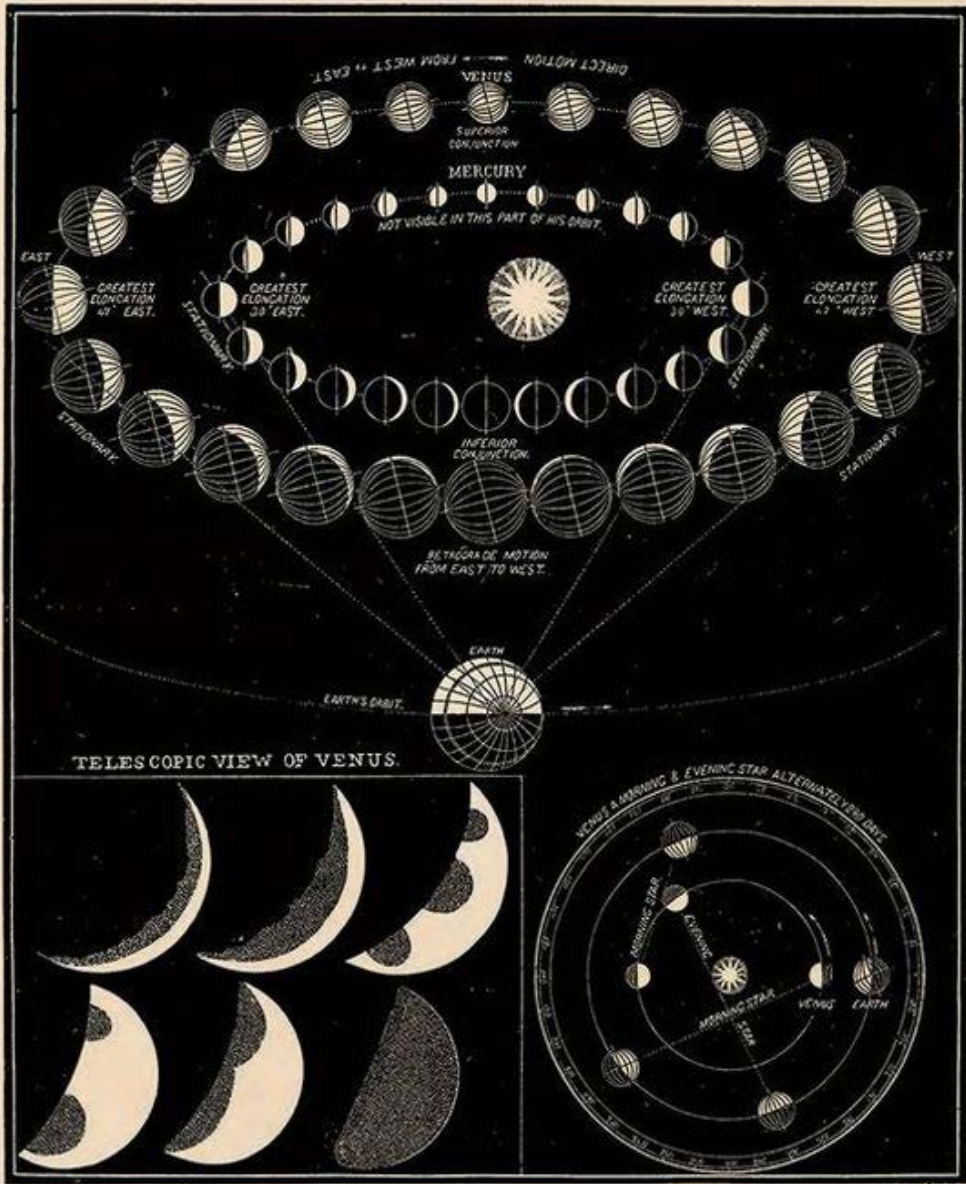

Astronomy.

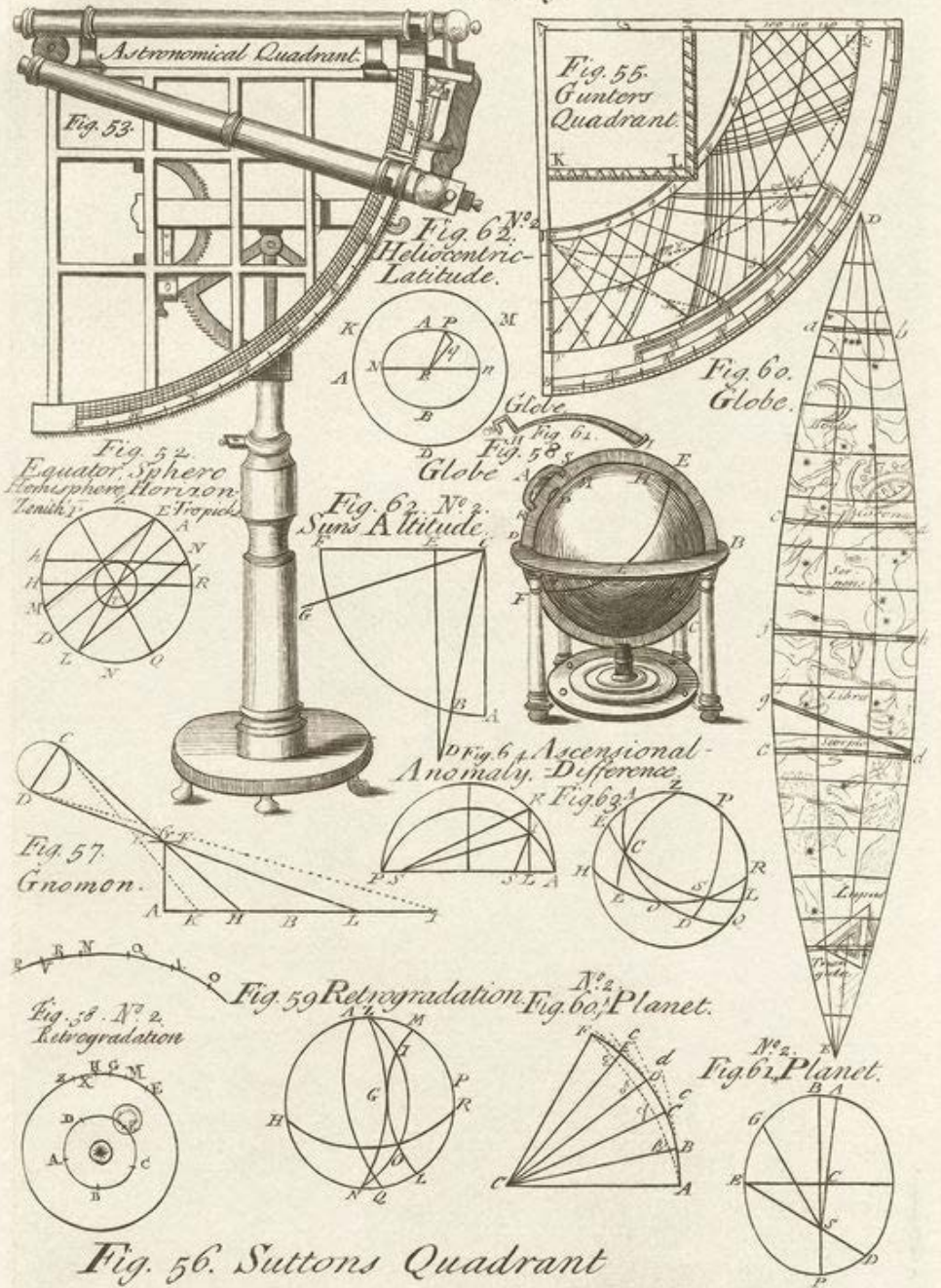



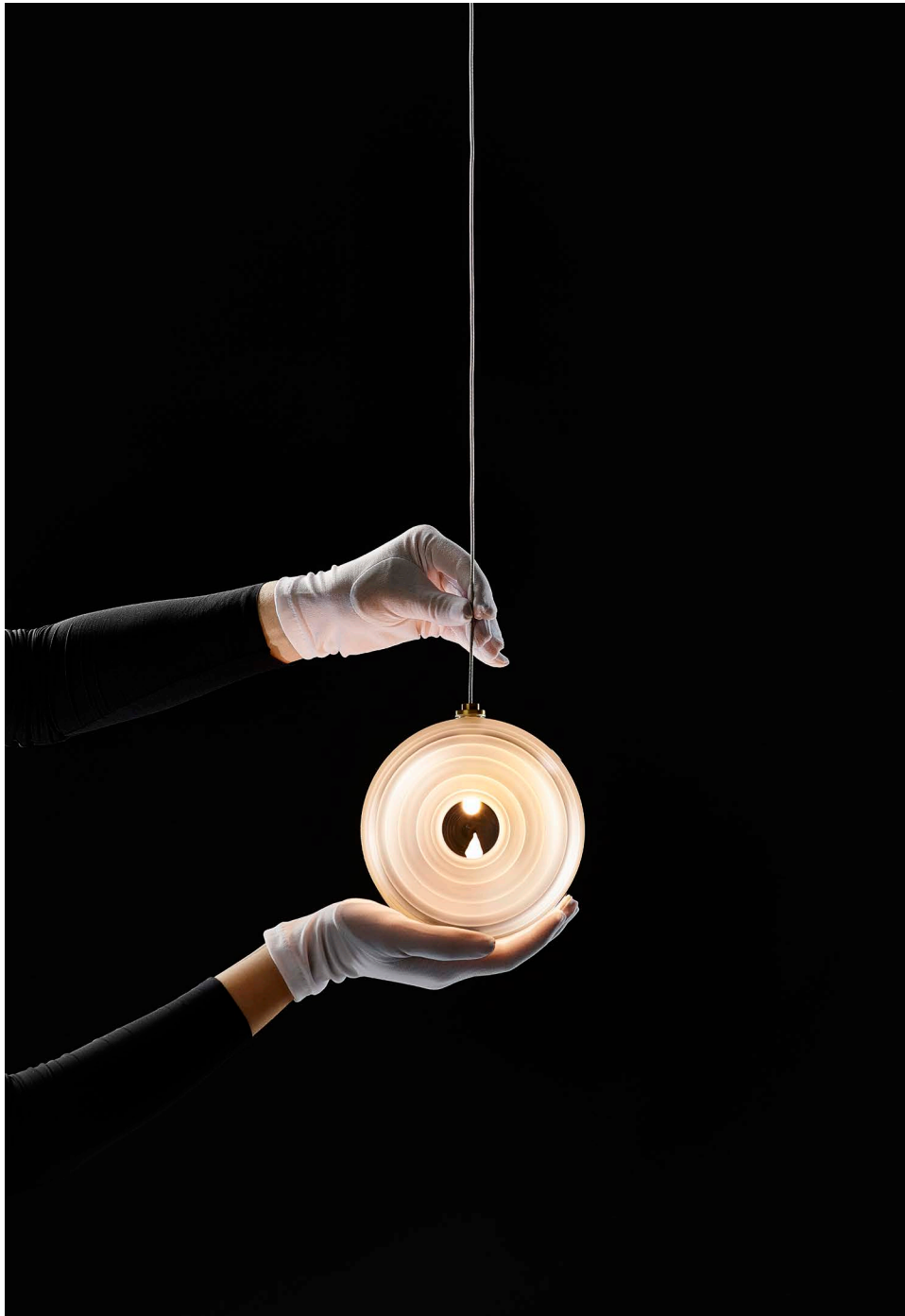

### DARK & BRIGHT STAR

The endless duel of light and darkness.

Like distant stars, these seemingly small lighted objects are powerful in both their design and craft. The light source is placed within a mouth-blown piece, the shining center of a precisely cut crystal star. Unique as a solitaire and even stronger in constellations.

Design by Dechem Studio

production









projects





BOMMA catalogue, 2021



BOMMA Atelier, Prague, 2021





Palermo Uno, Milan, 2018



Aufschnaiter showroom, Austria, 2020





TON catalogue, Prague, 2018

Installation of 26 pcs dark & bright stars



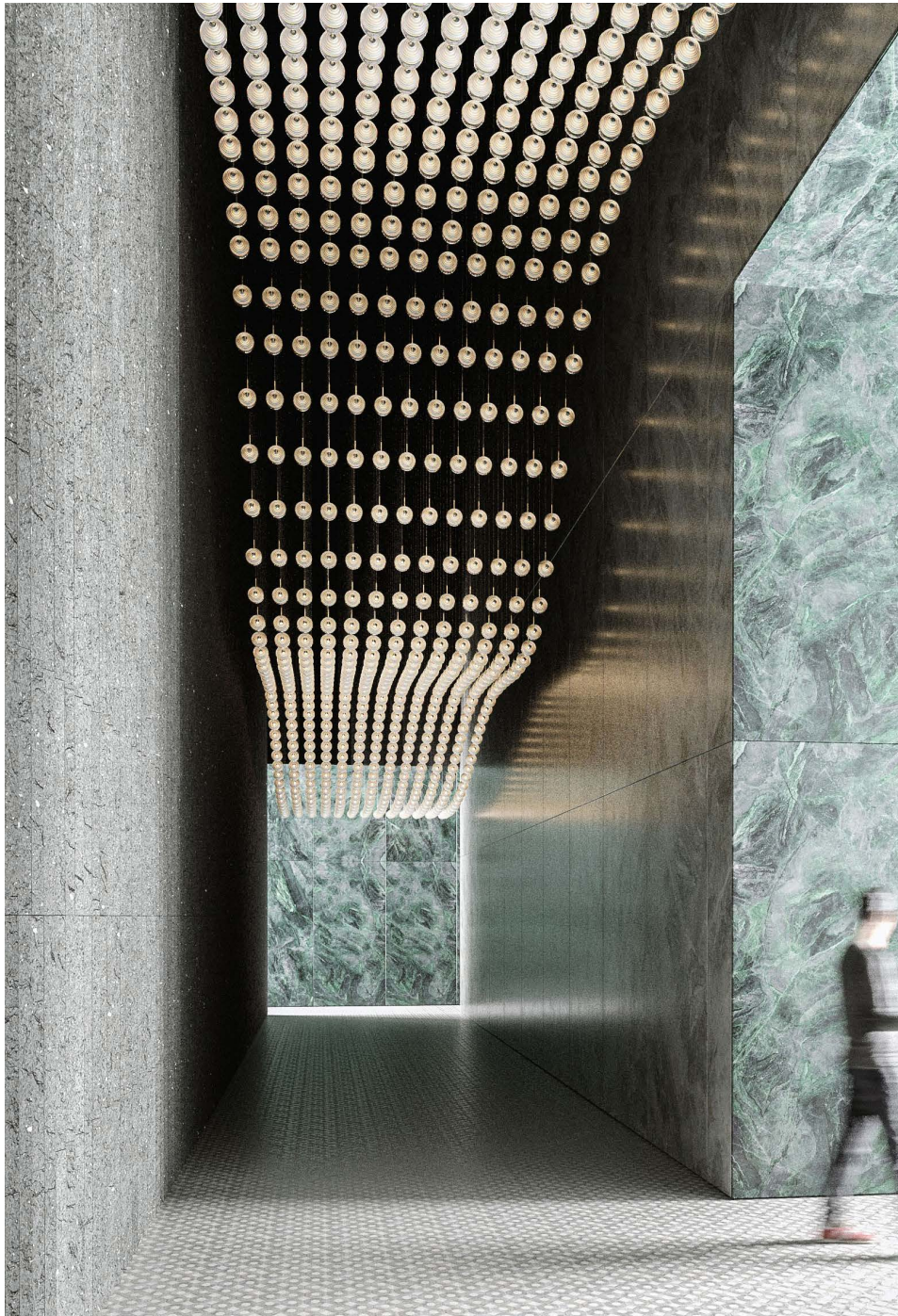

Installation of 650 pcs dark stars

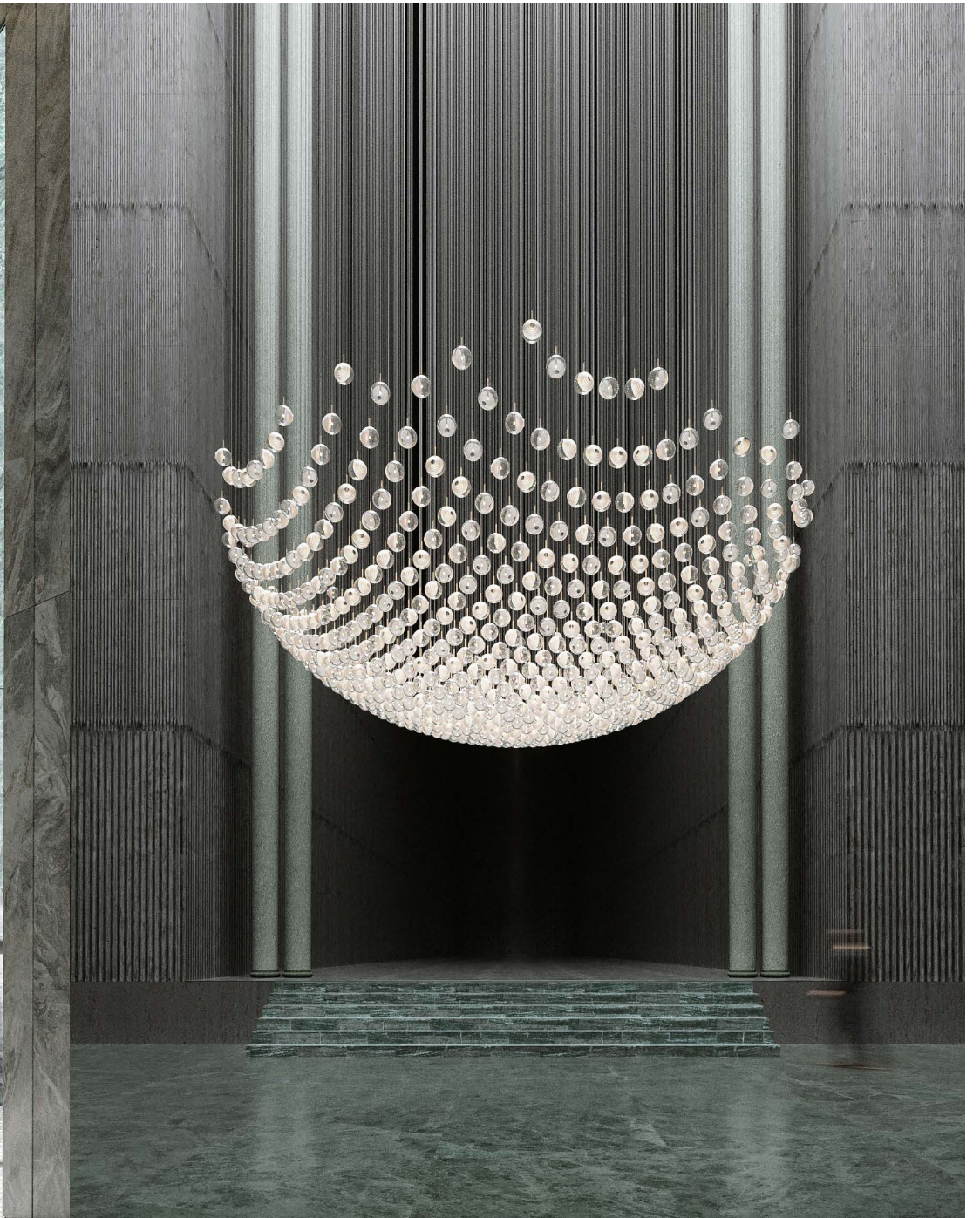

Installation of 881 pcs bright stars



options

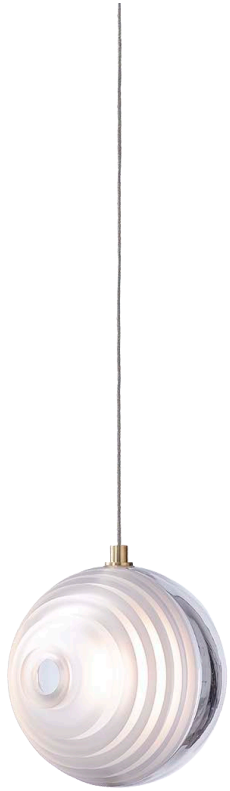

bright star - white  
brushed gold



bright star - white  
anthracite

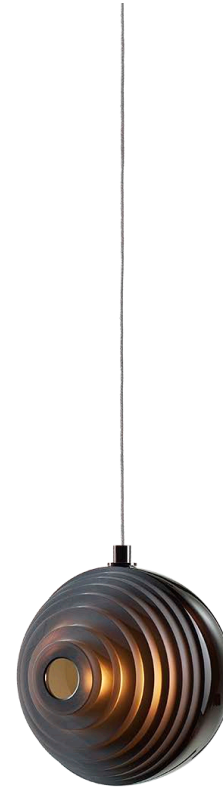

dark star - cigar  
anthracite

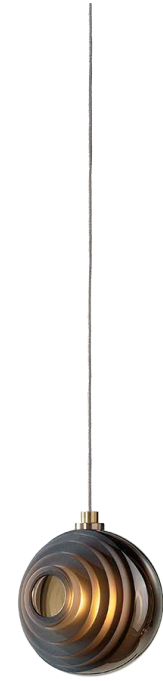

dark star - cigar  
brushed gold

# pendant

Glass options: cigar, white  
Fitting options: anthracite, brushed gold

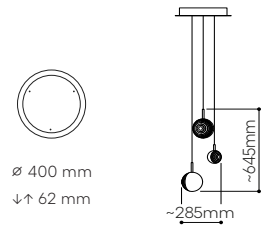

3 pendants

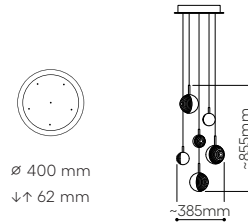

6 pendants

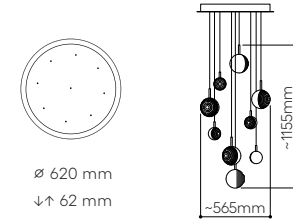

9 pendants

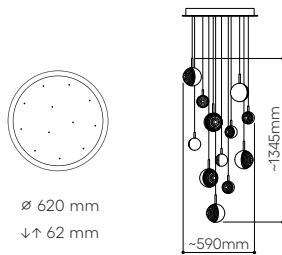

12 pendants

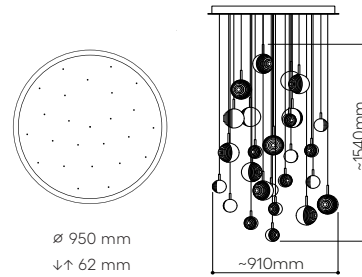

26 pendants

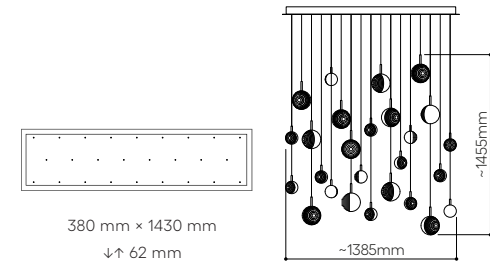

26 pendants  
rectangular

# chandeliers



technical informations

# DARK & BRIGHT STAR

## pendant large

Design by  
Dechem Studio

All Bomma products are hand-made from mouth-blown lead-free crystal. Therefore any small bubbles and/or irregularities in the glass are both a proof and a characteristic feature of this traditional craft.

The Dark and Bright Star Collection is produced in two colors, simply referred to as dark and bright. The bright version is clear glass with an opaque sanded finish, the dark version is made of fully-colored glass. Thanks to the manual process of blowing, each piece is an original. Individual products may vary slightly in hue or color intensity.

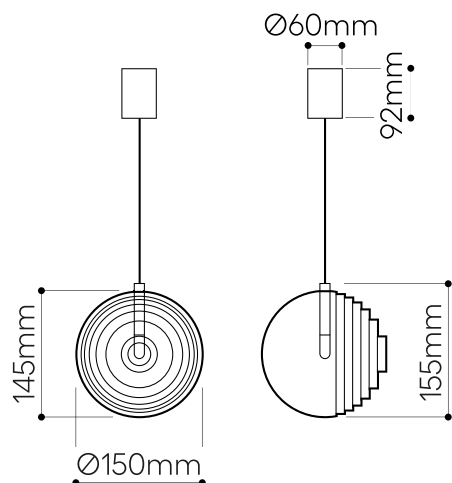

### LIGHTING DESCRIPTION

Size	dia. 150 mm, H 155 mm dia. 5,9 inch, H 6,1 inch
Cable	transparent 2,5 m / 98,4 inch
Weight	1,5 kg / 3,3 lb
Material	mouth-blown lead-free crystal in dark and bright
Mounting Materials	brushed brass / brass and galvanized black nickel
Mounting Colors	brushed gold / anthracit
Protection	IP 20
Nominal voltage	220-230V A.C. 50 hz (EU) 100-120 V A.C. 60 Hz (USA)
Class	II. EU / I. USA

### LIGHT SOURCE

Type	G4, 1,2W LED, 120 lm
Base	G4 (EU) / G4 (USA)
Voltage	12V, AC / 12V, AC
Temperature	2700 K
Color index	RA 90+
Dimming	Dimmable with 0/1-10VDC, on demand dimmable with TRIAC.

### TRANSFORMER

Primary	100-240V, 50/60 Hz, 0,04A
Dimmer	DC 700mA (0,5V-4V) 1x3W

### PACKAGING

Material	Cardboard
Size	230 × 220 × 220 mm 9 × 8,6 × 8,6 inch

Origin: traditionally produced in the Czech Republic  
Intellectual property license holder: Bomma Czech Republic (EU)  
represented by Bohemia Machine s.r.o.

# DARK & BRIGHT STAR

## pendant small

Design by  
Dechem Studio

All Bomma products are hand-made from mouth-blown lead-free crystal. Therefore any small bubbles and/or irregularities in the glass are both a proof and a characteristic feature of this traditional craft.

The Dark and Bright Star Collection is produced in two colors, simply referred to as dark and bright. The bright version is clear glass with an opaque sanded finish, the dark version is made of fully-colored glass. Thanks to the manual process of blowing, each piece is an original. Individual products may vary slightly in hue or color intensity.

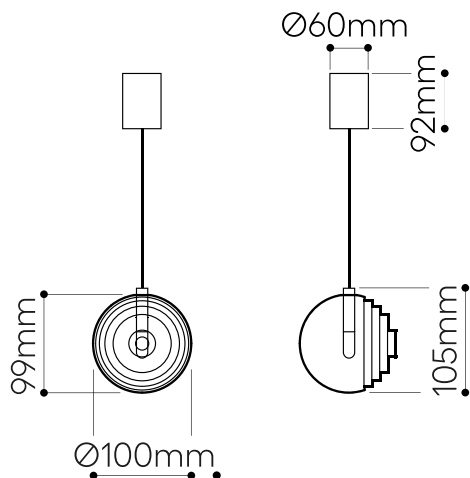

### LIGHTING DESCRIPTION

Size	dia. 100 mm, H 105 mm dia. 3,9 inch, H 4,1 inch
Cable	transparent 2,5 m / 98,4 inch
Weigh	0,7 kg / 1,54 lb
Material	mouth-blown lead-free crystal in dark and bright
Mounting Materials	brushed brass / brass and galvanized black nickel
Mounting Colors	brushed gold / anthracit
Protection	IP 20
Nominal voltage	220-230V A.C. 50 hz (EU) 100-120 V A.C. 60 Hz (USA)
Class	II. EU / I. USA

### LIGHT SOURCE

Type	G4, 1,2W LED, 120 lm
Base	G4 (EU) / G4 (USA)
Voltage	12V, AC / 12V, AC
Temperature	2700 K
Color index	RA 90+
Dimming	Dimmable with 0/1-10VDC, on demand dimmable with TRIAC.

### TRANSFORMER

Primary	100-240V, 50/60 Hz, 0,04A
Dimmer	DC 700mA (0,5V-4V) 1x3W

### PACKAGING

Material	Cardboard
Size	185 × 165 × 165 mm 7,3 × 6,5 × 6,5 inch

Origin: traditionally produced in the Czech Republic  
Intellectual property license holder: Bomma Czech Republic (EU)  
represented by Bohemia Machine s.r.o.



BMRC Group s.r.o.  
Hvězdova 1716/2b,  
Prague 4, 140 00,  
Czech Republic

[info@bomma.cz](mailto:info@bomma.cz)

step beyond